

2N4870, 2N4871

UNIUNCTION TRANSISTORS

FEATURES

- Available as "HR" (high reliability) screened per MIL-PRF-19500, JANTX level. Add "HR" suffix to base part number.
- Available as non-RoHS (Sn/Pb plating), standard, and as RoHS by adding "-PBF" suffix.

MAXIMUM RATINGS

Rating	Symbol	Value	Unit
RMS power dissipation ⁽¹⁾	P_D	300	mW
RMS emitter current	I_e	50	mA
Peak pulse emitter current ⁽²⁾	i_e	1.5	Amp
Emitter reverse voltage	V_{B2E}	30	Volts
Interbase voltage †	V_{B2B1}	35	Volts
Operating junction temperature range	T_J	-55 to 125	°C
Storage temperature range	T_{stg}	-55 to 150	°C

Note 1: Derate 3.04mW/°C increase in ambient temperature.

Note 2: Duty cycle ≤ 1%. PRR = 10PPS.

† Base upon power dissipation at $T_A = 25^\circ\text{C}$.

ELECTRICAL CHARACTERISTICS ($T_A = 25^\circ\text{C}$ unless otherwise specified)

Characteristic		Symbol	Min	Typ	Max	Unit
Intrinsic standoff ratio ($V_{B2B1} = 10\text{V}$) ⁽¹⁾	2N4870	η	0.56	-	0.75	-
	2N4871		0.70	-	0.85	
Interbase resistance ($V_{B2B1} = 3.0\text{V}$, $I_E = 0$)		R_{BB}	4.0	6.0	9.1	kohms
Interbase resistance temperature coefficient ($V_{B2B1} = 3.0\text{V}$, $I_E = 0$, $T_A = -65^\circ\text{C}$ to 125°C)		αR_{BB}	0.1	-	0.9	%/°C
Emitter saturation voltage ($V_{B2B1} = 10\text{V}$, $I_E = 50\text{mA}$) ⁽²⁾		$V_{EB1(\text{sat})}$	-	2.5	-	Volts
Modulated interbase current ($V_{B2B1} = 10\text{V}$, $I_E = 50\text{mA}$)		$I_{B2(\text{mod})}$	-	15	-	mA
Emitter reverse current ($V_{B2E} = 30\text{V}$, $I_{B1} = 0$)		I_{EB20}	-	0.005	1.0	μA
Peak point emitter current ($V_{B2B1} = 25\text{V}$)		I_P	-	1.0	5.0	μA
Valley point current ($V_{B2B1} = 20\text{V}$, $R_{B2} = 100\text{ohms}$) ⁽²⁾	2N4870	I_V	2.0	5.0	-	mA
	2N4871		4.0	7.0	-	
Base-one peak pulse voltage	2N4870	V_{OB1}	3.0	6.0	-	Volts
	2N4871		5.0	8.0	-	

Note 1: Intrinsic standoff ration: $VP = \eta VB2B1 + VF$, where VF is about 0.49V at 25°C @ $IF = 10\mu\text{A}$ and decreases with temperature at about 2.5mV/°C. Components R1, C1, and the UJT form a relaxation oscillator; the remaining circuitry serves as a peak -voltage detector. The forward drop of diode D1 compensates for VR. To use, the "cal" button is pushed and R3 is adjusted to make the current meter, M1, read full scale. When the "cal" button is released, the value of η is read directly from the meter, if full scale on the meter reads 1.0.

Note 2: Use pulse techniques: $PW \approx 300\mu\text{s}$ duty cycle ≤ 2% to avoid internal heating due to interbase modulation which may result in erroneous readings.

2N4870, 2N4871

UNIUNCTION TRANSISTORS

MECHANICAL CHARACTERISTICS

Case:	TO-92
Marking:	Alpha numeric
Pin out:	See below

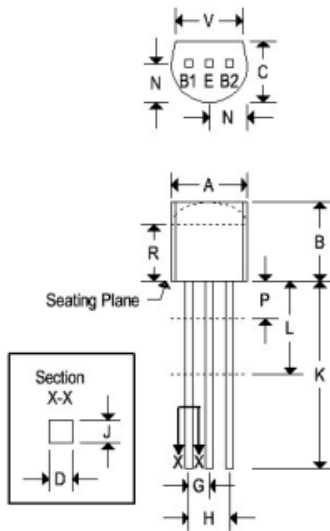

Dim	TO-92			
	Inches		Millimeters	
	Min	Max	Min	Max
A	0.175	0.205	4.450	5.200
B	0.170	0.210	4.320	5.330
C	0.125	0.165	3.180	4.190
D	0.016	0.021	0.407	0.533
G	0.045	0.055	1.150	1.390
H	0.095	0.105	2.420	2.660
J	0.015	0.020	0.390	0.500
K	0.500	-	12.700	-
L	0.250	-	6.350	-
N	0.080	0.105	2.040	2.660
P	-	0.100	-	2.540
R	0.115	-	2.930	-
V	0.135	-	3.430	-

2N4870, 2N4871

UNIUNCTION TRANSISTORS

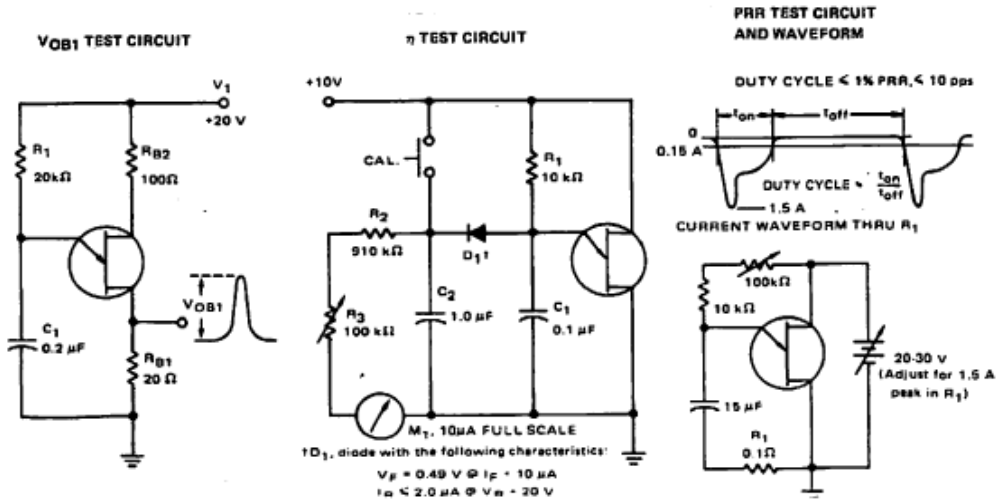

UNIUNCTION TRANSISTOR SYMBOL AND NOMENCLATURE

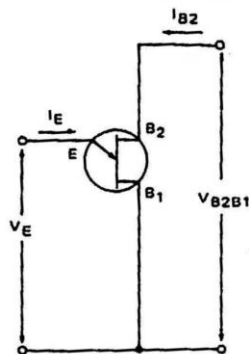

STATIC EMITTER CHARACTERISTICS CURVES

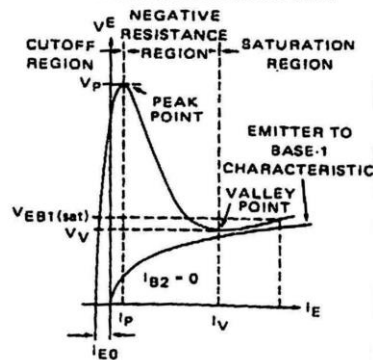

2N4870, 2N4871

UNIUNCTION TRANSISTORS

TYPICAL CHARACTERISTICS

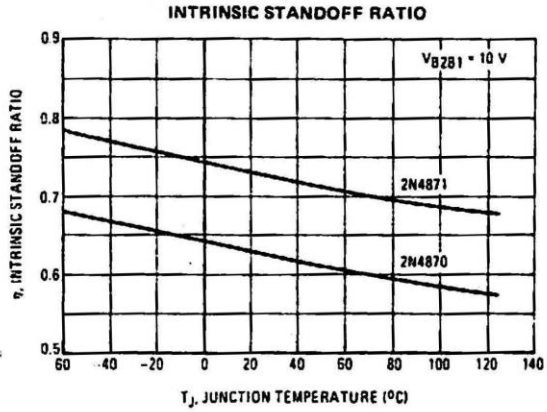
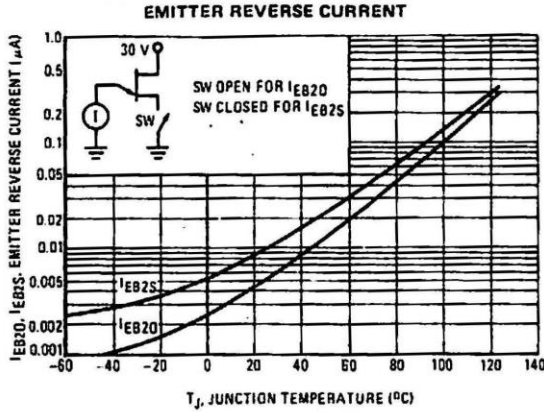

PEAK POINT CURRENT

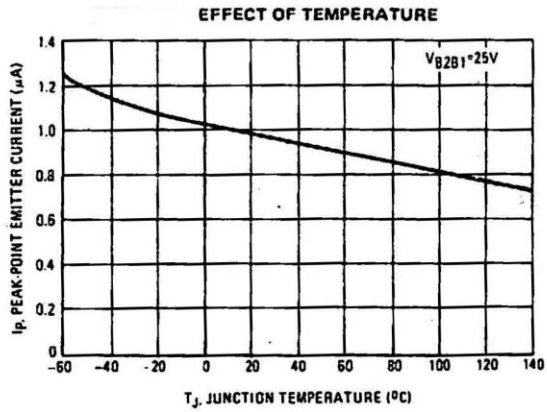
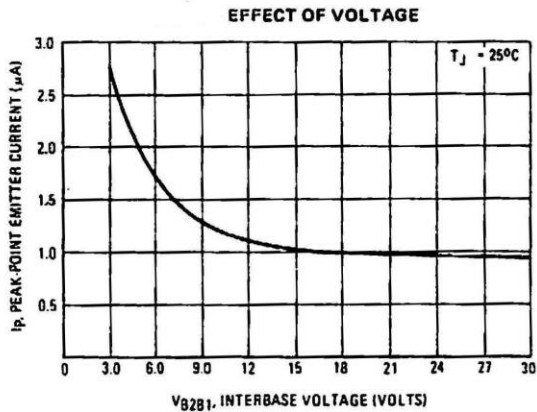

INTERBASE RESISTANCE

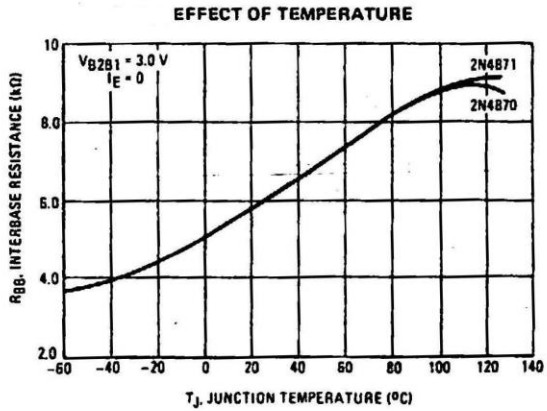
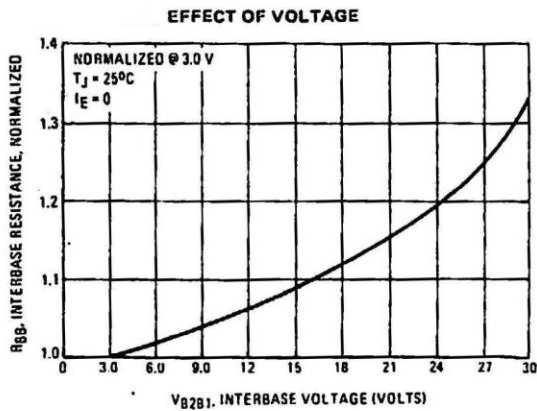

2N4870, 2N4871

UNIUNCTION TRANSISTORS

TYPICAL CHARACTERISTICS

VALLEY CURRENT

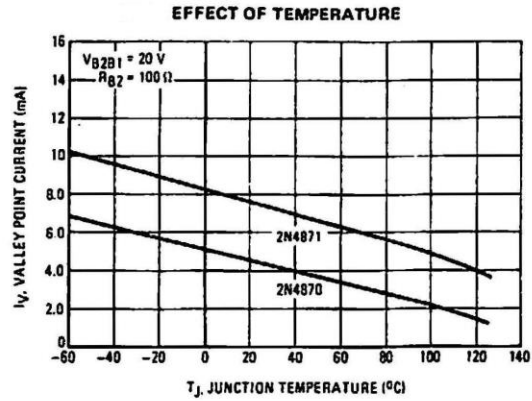
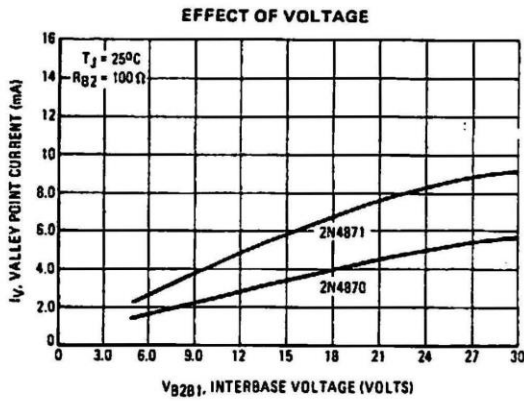

VALLEY VOLTAGE

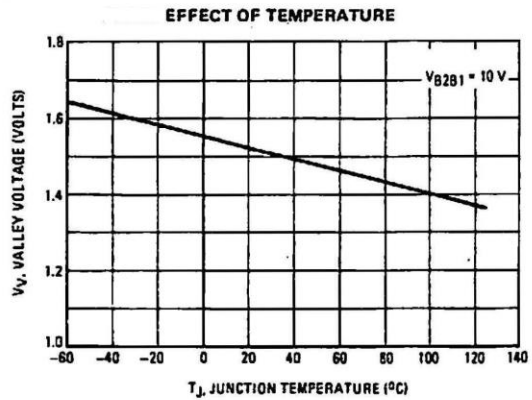
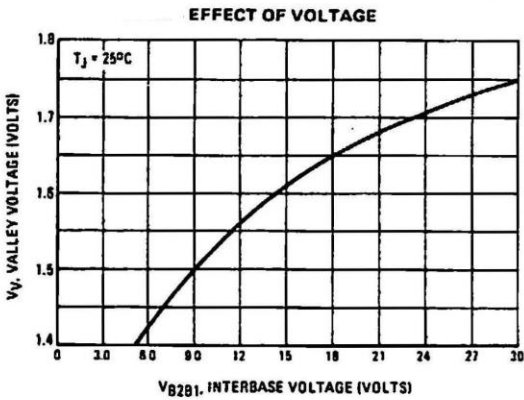

OUTPUT VOLTAGE

